

Quick Start Guide:

30 Minutes

Installing the Houdini Hardware™ Kit is easy and suitable for professionals and DIY enthusiasts. You'll only need basic tools and about 30 minutes to finish. Please read the instructions carefully before starting. Ensure your door is larger than the opening; for details, see pages 2-4. If you're installing a Metal Contemporary Door, follow pages 22-23 for accessory bracket installation.

- 1 Install Top Track:** Measure your door's width and subtract 3/16" to find the Top Track length. Trim the Top Track to this length using a suitable saw like a hack saw. (NOTE: No need to cut if your door slab is either 36" or 48".) Attach the Top Track to the upper backside of the door using the provided fasteners, aligning it with the top edge (remember to drill pilot holes). Next, insert (2) Soft-Close Dampers and (2) Hard Stops into the Top Track. Snap on (2) End Caps. Slide the Hard Stops outward to meet the End Caps and position the Dampers against the Hard Stops. Tighten everything securely, but do not over-tighten. **Refer to pages 5-9 for more detailed instructions on this step.**
- 2 Install Bottom Track:** Trim the Bottom Track to match the length of the Top Track using the saw. (NOTE: No need to cut if your door slab is either 36" or 48".) Attach the Bottom Track to the door's bottom edge using the provided fasteners (remember to drill pilot holes). Install the (2) Bottom Wheel Assemblies by sliding their guides into the slot in the Bottom Track. Snap on (2) End Caps. Slide each Wheel Assembly outward to meet the End Caps and tighten the (2) screws on each assembly. **For additional details, refer to pages 10-12.**
- 3 Attach Wall Mount:** Determine if your door will open **left** or **right**. Position the door with the Bottom Track and Wheels against the chosen side of the wall opening. Use a pencil to mark a line on the wall *at the top of the Top Track*; this line should align with the Wall Mount's top edge. For the door to Fully Open to the width of the wall opening, attach the Wall Mount (using 6 fasteners) 1 inch to the right or left of the wall opening's edge. **Further details can be found on pages 14-17.**
- 4 Attach Door Floor Guide:** Position and install the Door Floor Guide directly beneath the center point of the Wall Mount and align it with the center of the Bottom Track. Secure it in place with (2) screws. If needed, you can make slight adjustments after installation by pivoting the Door Floor Guide within the elongated slot at one end. **Refer to pages 18-19 for detailed instructions on this step.**
- 5 Install Door:** Stand the Door Slab upright with all hardware securely attached. Ensure the door's center aligns roughly with the Wall Mount's location. Two individuals should lift the Door Slab approximately 1 inch above the Door Floor Guide, engage the wheel rollers with the Wall Mount, and then lower the door over the Floor Guide. Once the door operates smoothly, locate the (2) anti-jump bars at the top of the Wall Mount. Rotate each 90 degrees to extend them over the Top Track and tighten with a screwdriver. This is a crucial step for safe door operation, preventing it from disengaging. **The weight of the Door Slab is carried by the Wheel Assembly & Bottom Track. The Wall Mount is ONLY designed to be a guide and to keep the Door Slab in an upright position. The Wall Mount does NOT support any weight of the door.**

PARTS & TOOLS:

- I. Parts Provided in the Kit: The screws and anchors included with the Houdini Hardware™ Kit may not be suitable for all installations applications.

Houdini Hardware™ KIT CONTENTS

- | | |
|--------------------------------|-------------------------------------|
| A WALL MOUNT (X1) | G SOFT-CLOSE DAMPER (Left) |
| B TOP TRACK (X1) | H SOFT-CLOSE DAMPER (Right) |
| C BOTTOM TRACK (X1) | I BOTTOM WHEEL ASSEMBLY (X2) |
| D DOOR FLOOR GUIDE (X1) | J TOP TRACK END CAPS (X2) |
| E HARD STOP (Left) | K BOTTOM TRACK END CAPS (X2) |
| F HARD STOP (Right) | L SET OF FASTENERS (X1) |

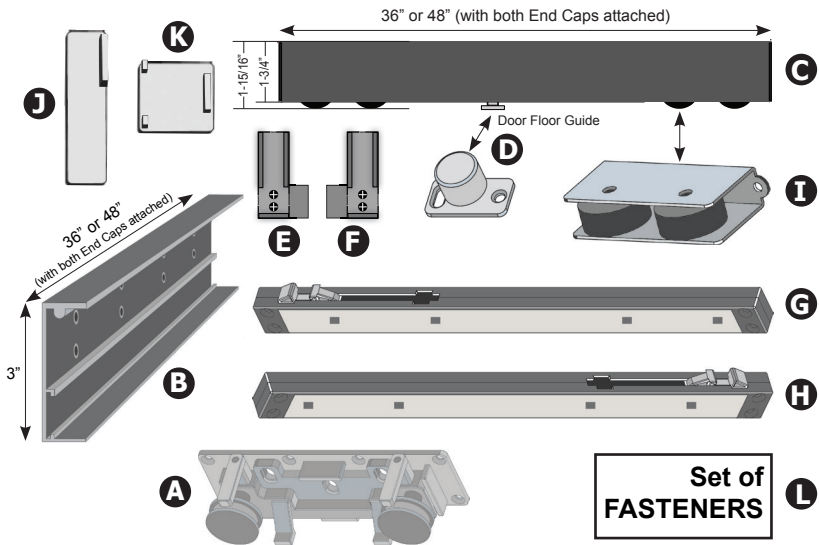

- II. Tools Required for Installation:

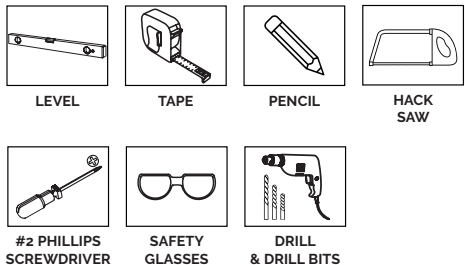

INSTALLATION REQUIREMENTS:

MAGIC TIP



Before proceeding with the installation, it's essential to confirm that the location for the door is suitable for a proper & safe installation. The installation's uniqueness is contingent upon both the dimensions of the wall opening and the specific door you've chosen to pair with the Houdini Hardware™ Kit.



Houdini Hardware™ KITS

Item #BDHH36

- Doors up to 36" wide.

Item #BDHH48

- Doors over 36" wide and up to 48" wide.

Item #BDHHA

- Special Adapters are required specifically for metal barn door installation.

- III. Make sure the door will be installed on a hard surface such as hardwood or tiled floors. Since 100% of the door's weight is on wheels and rolls on the floor, this system is not compatible with most carpet. (A tightly-weaved carpet could possibly work.)

Check for casing (wood trim) around the wall opening. The casing cannot exceed more than 5/8 inch from the wall. The baseboard & shoe molding should not exceed 1-1/2 inches from the wall. The door can not be properly installed if any of these items are in the way of the door, preventing it from opening and closing.

We recommend selecting a GlassCraft Barn Door for use with our Houdini Hardware™ Kit, as they have been specifically designed with these doors in mind. This ensures a seamless installation without potential complications. Choose one of our many barn doors and associated products from our online catalog.

BarnCraft
Sliding Doors
Catalog



INSTALLATION REQUIREMENTS:

- IV. Decide the preferred direction for the door to open—either from **RIGHT to LEFT** or **LEFT to RIGHT**. It's important to consider potential obstructions, such as a light switch, that may dictate the door's opening direction. Ensure you double-check measurements on both sides of the wall opening to ensure ample clearance for the door to safely open (refer to *Attach Wall Mount* on page 14).

Next, determine the range of how much the door will open. The door can **Fully Open** (the door edge can open to the full width of the wall opening) or the door can and be **Partially Open** (the open door will cover a portion of the wall opening). For further details, refer to *Install the Top Track* on page 9.)

This door **FULLY OPENS**, opening from Left-To-Right.

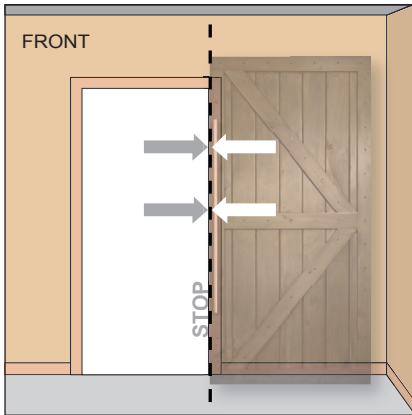

This door **PARTIALLY OPENS**, opening from Left-To-Right.

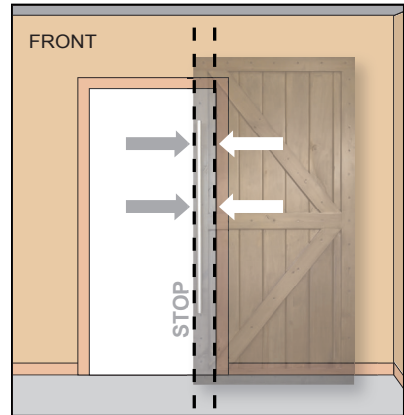

A **Partially Open** door that stops short of being flush from the wall opening allows a person to grab the door to open or close.

A recessed handle can be installed as shown in the image.

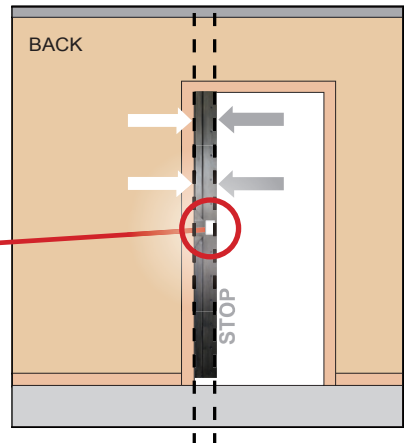

Scan HERE to visit The DoorCrafter for VISTA Handle options.

INSTALLATION REQUIREMENTS:

V. How To Determine Your Door Size:

Determine the DOOR WIDTH

For a **Fully Open** installation, it is recommended that the width of the door is at least 8" greater than the width of the wall opening. This type of installation *does not block* any of the wall opening; the edge of the door is flush with the edge of the wall opening (if the wall is level).

Example: if the wall opening is 30", then a minimum door size of at least 38" will be needed, allowing for 4 inches on each side of the door.

For a **Partially Open** installation, it is recommended that the width of the door is at least 8" greater than the width of the opening as well. However, this type of installation *does block* some of the wall opening; the edge of the door sticking out, not flush with the edge of the wall opening. (For further information on adjusting the distance the door opens & closes, see page 9)

Determine the DOOR HEIGHT

If the Bottom Track is to be attached directly to the bottom of the door (Standard Installation), measure from the Top Track (installed on the backside of the door) down to the floor and add 1 inch to the height. If casing (wood trim) is present, measure from the top of the casing to the bottom of the finished floor and add 1 inch to the height.

If the Bottom Track is to be installed and recessed inside the door (see page 13, "Special Installation"), measure from the Top Track (installed on the backside of the door) down to the floor and add 2-1/2" to the height. If casing (wood trim) is present, measure from the top of the casing to the bottom of the finished floor and add 2-1/2".

MAGIC TIP



Choosing the correct door size depends upon if your wall opening is surrounded by decorative casing or molding. **(Casing cannot be more than 5/8" deep).**

Scan HERE
to watch our
INSTALLATION
VIDEO



INSTALLATION STEPS:

STEP ONE: Install Top Track

Determine the SIZE to CUT the TOP TRACK



NOTE: You do not need to cut the Top Track if your Door Slab is already 36" or 48".

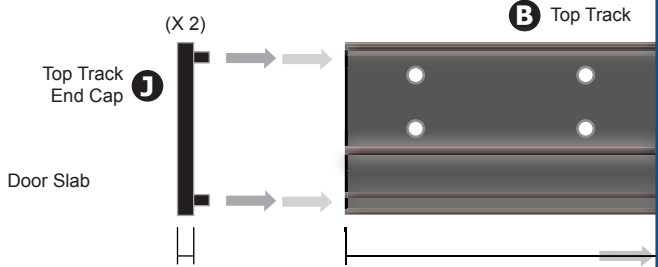

$$\text{Width of Door Slab} - \frac{3}{16} \text{ inch} = \text{Measurement for BOTH End Caps combined} = \text{Cut Top Track to THIS SIZE}$$

A. Cut -

After determining the Cut Width of the Top Track, you'll need a saw that can cut aluminum. Use this saw to cut the Top Track to exact size.

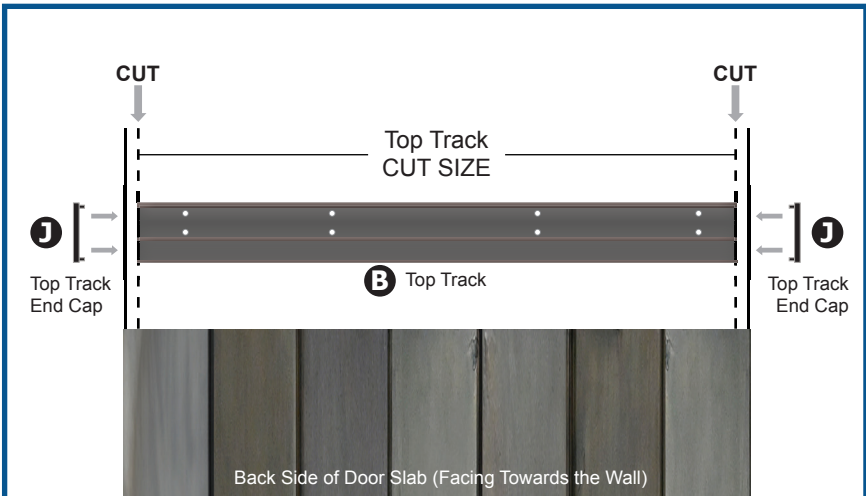

INSTALLATION STEPS:

STEP ONE: Install Top Track

B. Position -

Place the Top Track on the back of the Door Slab - the side that faces the wall. Make sure the Top Track is **centered** and **flush** with the top of the Door Slab.

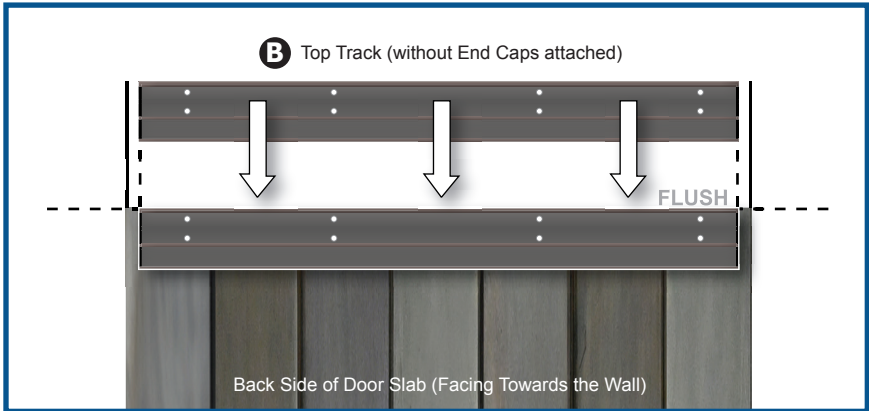

C. Drill -

Make sure the Top Track is secure and in the correct location before drilling. Afterwards, pre-drill holes for the supplied screws.



Before drilling, make sure your drill bit is *smaller* than the screws you're using to attach the Wall Mount. It is recommended to use a 1/8" drill bit.

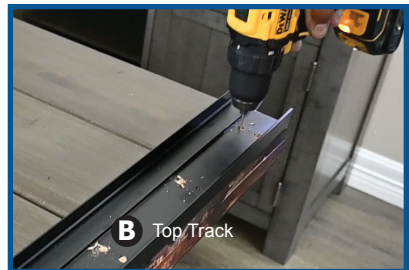

DISCLAIMER: The Houdini Hardware™ Kit should not be altered in any fashion. The Houdini Hardware™ Kit should only be used for the intended purpose. The weight capacity for the Houdini Hardware™ Kit should not exceed (80kg/176 lbs.). The Houdini Hardware™ Kit should be installed as instructed in this booklet. The screws and anchors included with the Houdini Hardware™ Kit may not be suitable for all installations applications.

INSTALLATION STEPS:

STEP ONE: Install The Top Track

D. Attach -

Use supplied screws to attach the Top Track to the top of the Door Slab. Make sure the Top Track is located on the back side of the Door Slab - the side facing the wall.

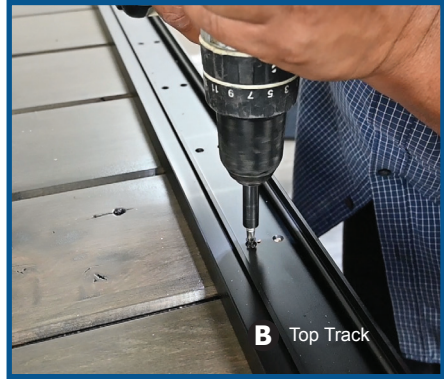

E. Install -

Install the Soft-Close Damper mechanisms by sliding them into place on the lower guide rail of the Top Track. **Do Not Tighten Screws yet on Soft-Close.**

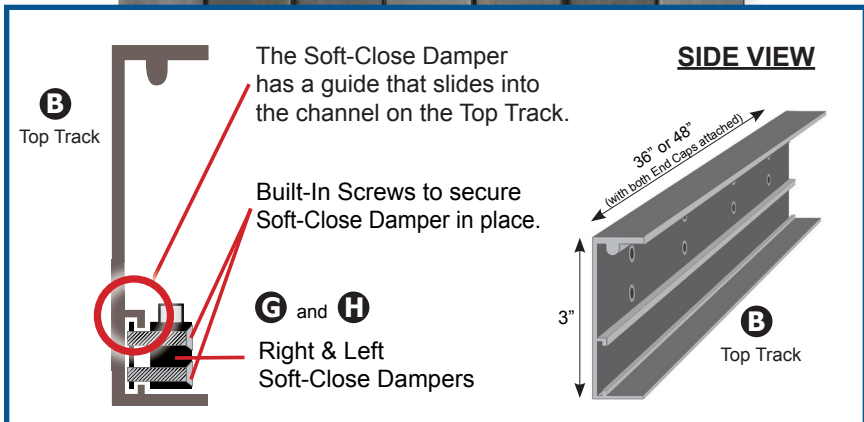
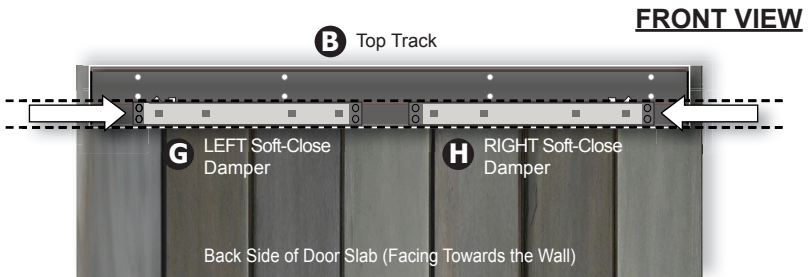

INSTALLATION STEPS:

STEP ONE: Install The Top Track

The following steps show how to install the **Soft-Close Damper**, the **Hard Stop** and the **Top Track End Cap**. These instructions apply for installing on both sides of the Top Track.

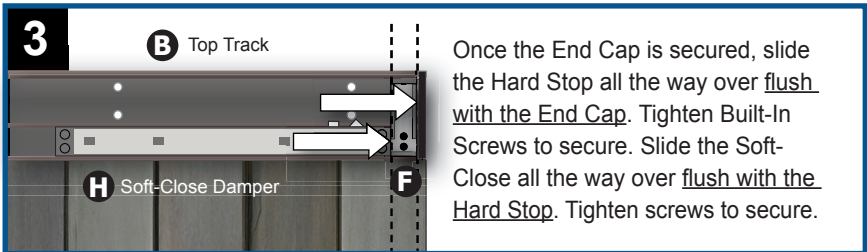
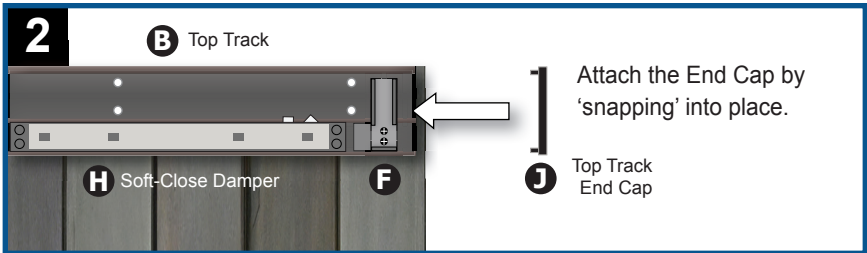
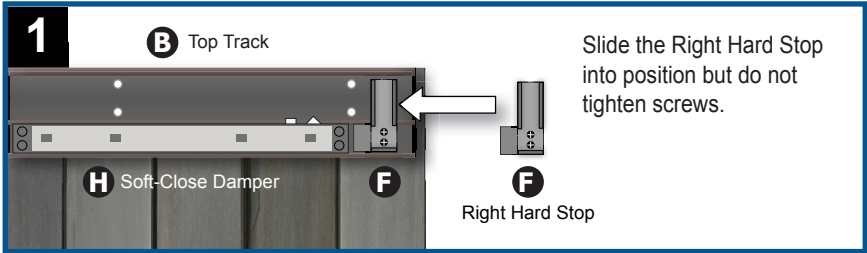

Install the Soft-Close Damper on correct side. This will allow the Soft-Close to engage when triggered by the Top Track moving into position.

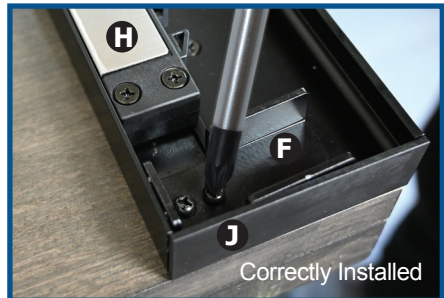
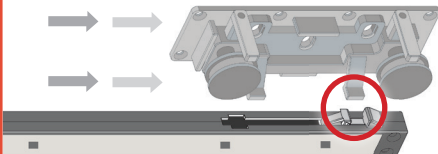

INSTALLATION STEPS:

STEP ONE: Install The Top Track

The Hard Stops, when secured into position on the Top Track, determine where exactly the door will stop when opened & closed. The Hard Stops can be positioned based on personal preference of where you'd like to door to stop when opened or closed. See the images below:

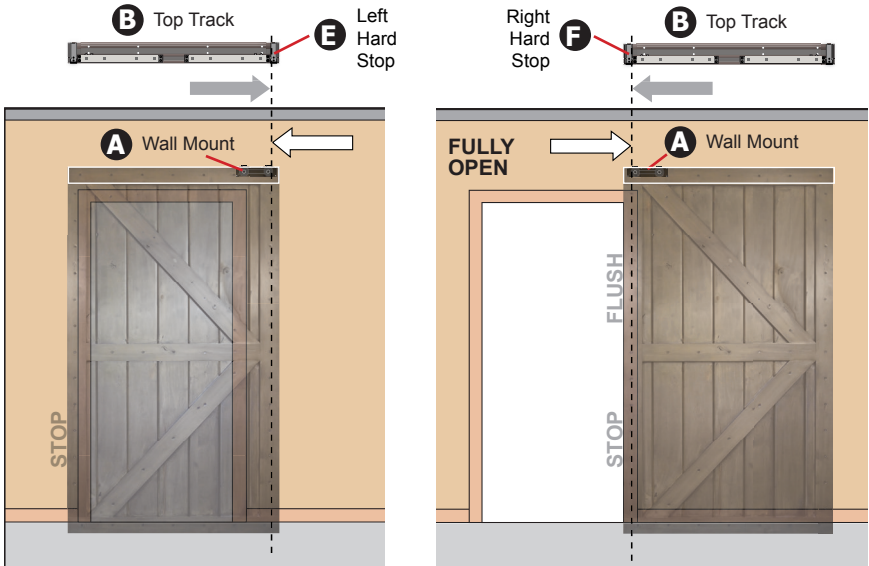

Reposition the Hard Stop (and the Soft-Close Damper) by sliding them inwards. Then tighten all screws to secure in position. The door is now unable to fully open.

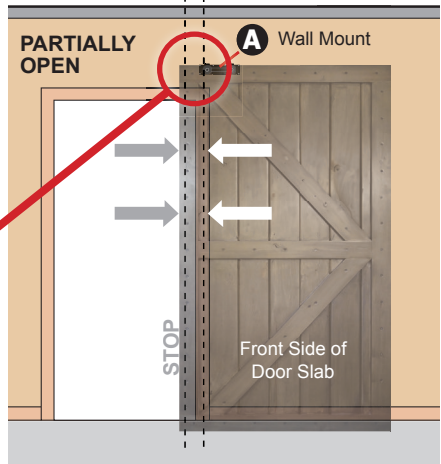

INSTALLATION STEPS:

STEP TWO: Install The Bottom Track

Determine the SIZE to CUT the BOTTOM TRACK



Door Slab

NOTE: You do not need to cut the Bottom Track if your Door Slab is already 36" or 48".

K Bottom Track End Cap (X2)



C Bottom Track

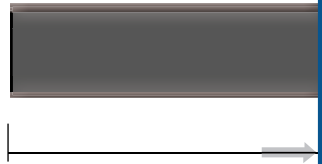

$$\text{Width of Door Slab} - \frac{3}{16} \text{ inch Measurement for BOTH End Caps combined} = \text{Cut Top Track to THIS SIZE}$$

By subtracting the width of **BOTH** End Caps from the width of the Door Slab (3/16"), this will allow the **Bottom Track to be flush at both ends** after installation with both End Caps attached..

A. Cut -

After determining the Cut Width of the Bottom Track, you'll need a saw that can cut aluminum. Use this saw to cut the Bottom Track to exact size.

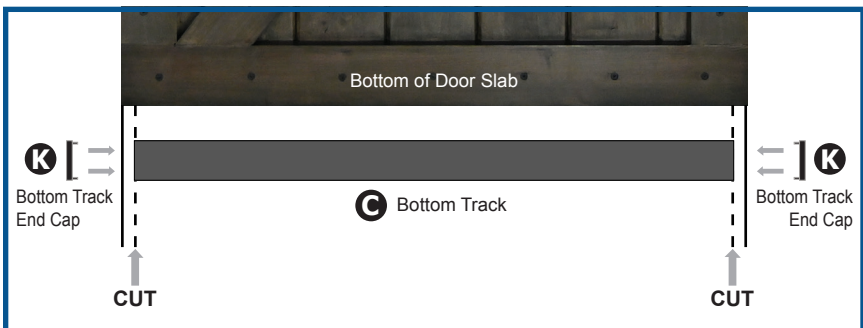

INSTALLATION STEPS:

STEP TWO: Install The Bottom Track

B. Position -

Place the Bottom Track on the bottom of the Door Slab. Make sure the Bottom Track is **centered** and **flush** with the bottom of the Door Slab.

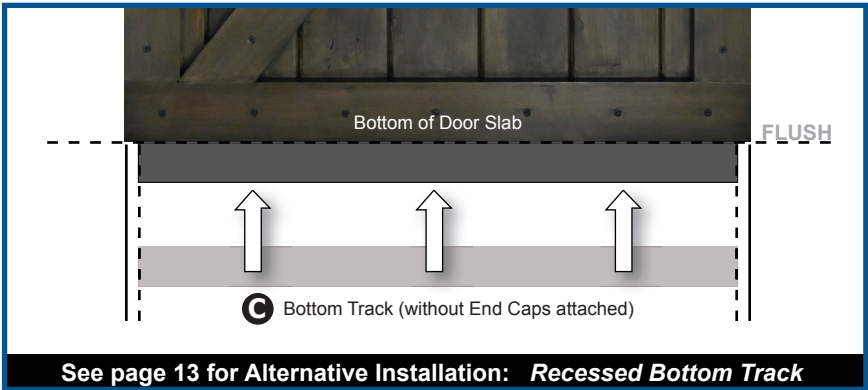

C. Drill -

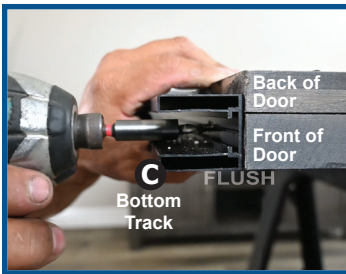

Make sure the Bottom Track is **flush with the front of the door** and in the correct location before drilling. Pre-drill holes into the door for the supplied screws. Then use the provided screws and attach the Bottom Track to the bottom of the Door Slab.

D. Install -

Install the Wheels into the Bottom Track. Line up the channel guides on top of the Wheels to allow them to properly slide into the Bottom Track channel.



INSTALLATION STEPS:

STEP TWO: Install The Bottom Track

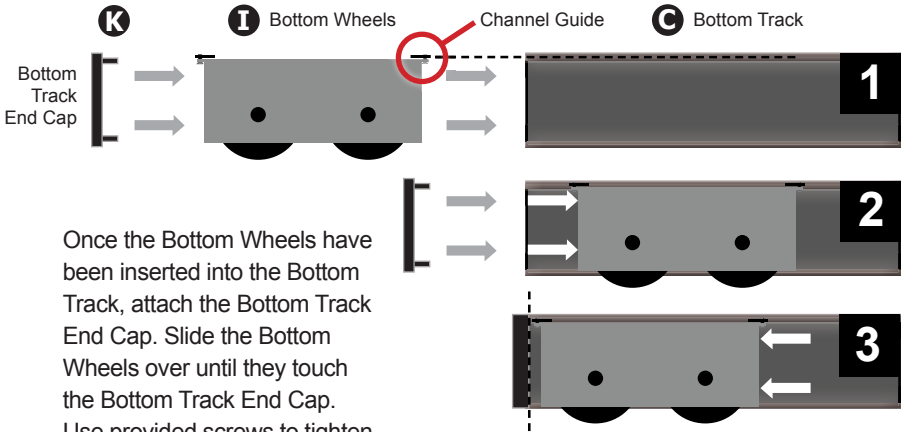

Once the Bottom Wheels have been inserted into the Bottom Track, attach the Bottom Track End Cap. Slide the Bottom Wheels over until they touch the Bottom Track End Cap. Use provided screws to tighten Bottom Wheels in position.



MAGIC TIP After installing the Bottom Track (Wheels attached) to the bottom of the door, the door has increased in height by 2".

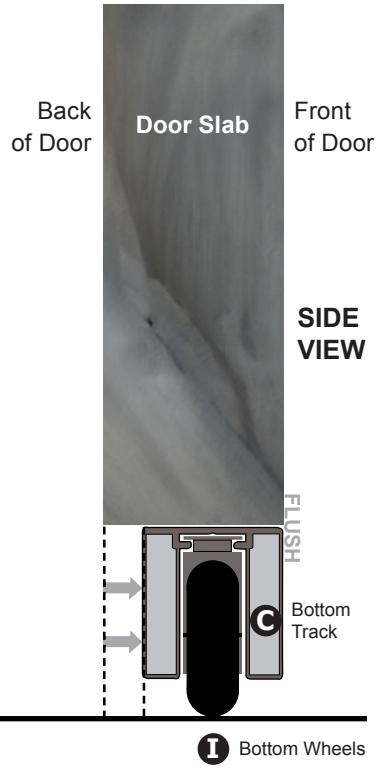

Make certain that the Bottom Track is moved forward to be completely FLUSH with the front side of the door before installation (as shown in the image to the right).

INSTALLATION STEPS:

STEP TWO: Alternative Installation - *Recessed Bottom Track*

For a completely hidden and concealed hardware appearance, mount the Bottom Track **INSIDE** (and not **ON**) the bottom edge of the door. This requires routing an edge-to-edge slot in the bottom of, at least, a 1-3/4" thick door.

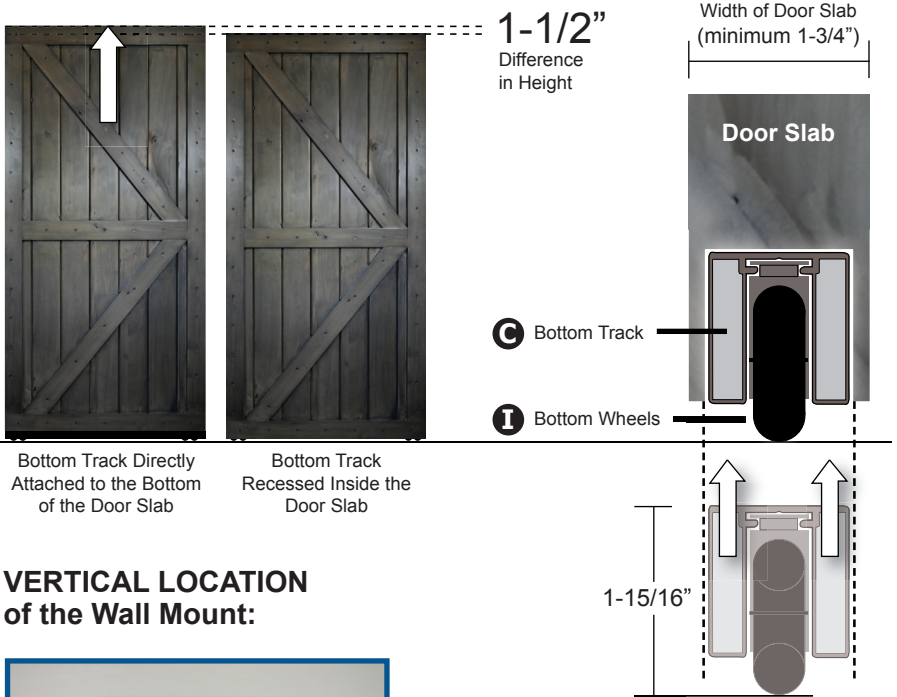

VERTICAL LOCATION of the Wall Mount:

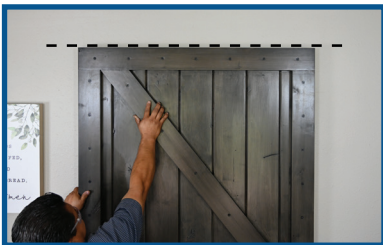

To figure out exactly how high the Wall Mount should be installed on the wall, lift the Door Slab up and position as closely as you can to the wall. This step may require two people to perform. See page 14 for further information.

Make sure the Recessed Bottom Track (with Bottom Wheels) and Top Track are attached to the Door Slab before attempting to use to determine the height of where the Wall Mount is to be installed. With the Bottom Track & Wheels recessed inside the Door Slab, once the Door Slab is raised and leaned against the wall, we can easily determine the height where the Wall Mount is to be installed. (Proceed to STEP 3.)

INSTALLATION STEPS:

STEP THREE: Attach Wall Mount

Determine the VERTICAL LOCATION of the WALL MOUNT

Make sure the **Bottom Track (with Bottom Wheels)** and **Top Track** are attached to the **Door Slab** before attempting to use to determine the height of where the **Wall mount is to be installed**. With the Bottom Track & Wheels attached, once the door is raised against the wall, we can easily determine the height where the Wall Mount is to be installed.



To determine the Wall Mount's vertical position, raise and position the door parallel to the wall (as seen in the image to the left). Once in position, **use a pencil to mark the top of the Top Track**, not the top of the door. This measurement is your vertical position.



When drawing the pencil line on the wall, make sure to hold the pencil correctly as to get an accurate measurement. See both images on the right for proper alignment.

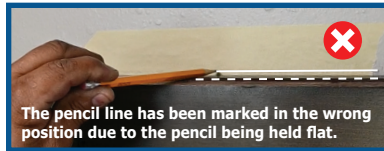

The pencil line has been marked in the wrong position due to the pencil being held flat.

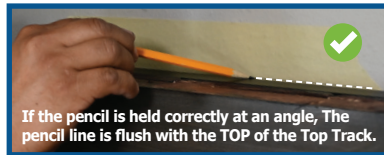

If the pencil is held correctly at an angle, The pencil line is flush with the TOP of the Top Track.

Height of the Wall Mount



PENCIL LINE

Wall Opening

Total Height of Door Slab
Top Track & Bottom Track
(with Wheels) attached to Door Slab

INSTALLATION STEPS:

STEP THREE: Attach Wall Mount

Determine the HORIZONTAL LOCATION of the WALL MOUNT

We've determined the height of the Wall Mount. Now let's determine how far to the *LEFT* or *RIGHT* we need to position the Wall Mount. Determining the left and right positioning of the Wall mount significantly impacts your door's open and closed positions. There are two options:

1. FULLY OPEN:

- Place Wall Mount 1 inch beyond the edge of the wall opening.
- At least 8" wider than the wall opening, preferably wider if possible.
- Door height: Equal to or taller than wall opening's height.

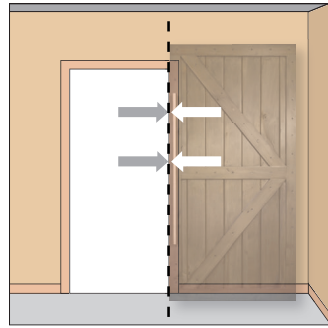

MAGIC TIP



The Wall Mount can be placed flush with the wall opening, or it can be centered above the wall opening. If **Fully Opened**, the edge of the door is flush with the wall opening. If **Partially Opened**, the door will overhang beyond the wall opening roughly 3-7/8". (See image on next page, *Partially Open*.)

FULLY OPEN

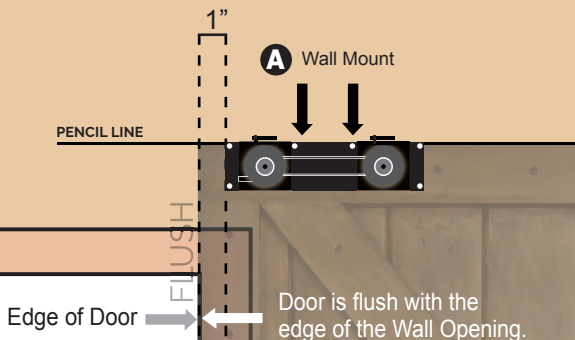

INSTALLATION STEPS:

MAGIC TIP



The weight of the Door Slab is carried by the Wheel Assembly in the Bottom Track. The Wall Mount is only designed to be a guide and to keep the Door Slab in an upright position. The Top Track should not ride on the rollers of the Wall Mount.

For the Partially Open option, your door will need to be at least 8 inches wider than the existing wall opening. (Using a wider door is preferred.) And your door needs to be as tall or taller than the height of the existing doorway opening.

2. PARTIALLY OPEN:

- Position Wall Mount at or slightly overlapping the wall opening.
- Wall opening width + 8" is the minimum door width.
- Equal to or taller than the wall opening's height is the minimum door height.

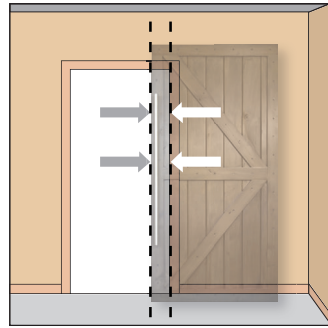

To position Wall Mount properly, place it slightly overlapping the wall opening. For this setup, ensure your door width meets these criteria: Subtract the desired coverage (e.g., 6") from the opening width 7-3/4". For instance, with a 40-inch wall opening, your minimum door width should be 41.5 inches. In this case, a standard 42-inch-wide door is recommended.

PARTIALLY OPEN

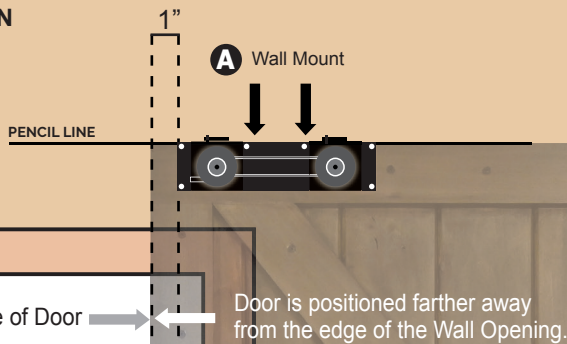

INSTALLATION STEPS:

STEP THREE: Attach Wall Mount

B. Attach -

Once you have determined the Wall Mount's vertical and horizontal position (How High / Left or Right), now it's time to accurately position & attach the Wall Mount. The Wall Mount has (6) pre-drilled holes where screws will be used to attach to the wall. Once the Wall Mount is in position on the wall, use a pencil to mark all (6) holes, then remove the Wall Mount.

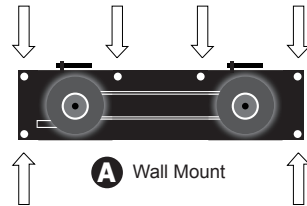

Next, pre-drill all (6) pencil marks. Use supplied screws & anchors to attach Wall Mount. **Do Not Over-Tighten.**



MAGIC TIP Rather than making marks directly to the wall, tape can be applied over the area (as seen in the image) and removed after use.

FULLY OPEN

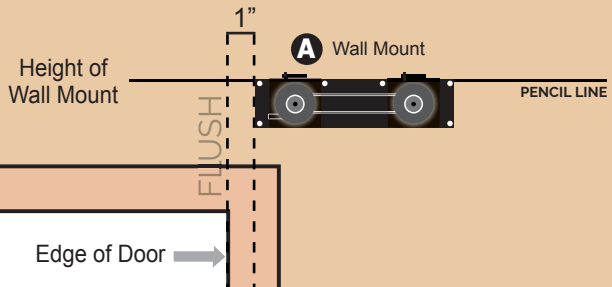

INSTALLATION STEPS:

STEP FOUR: Attach Door Floor Guide

A. Position -

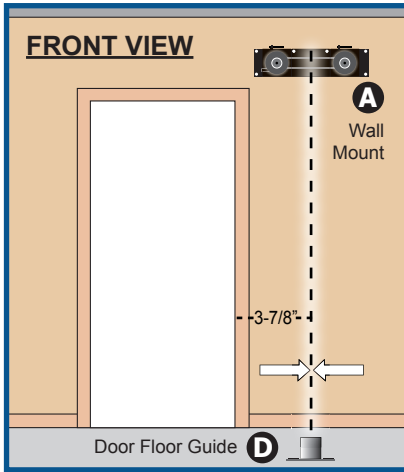

1 Horizontal Position

After the Wall Mount has been attached, you can determine the left or right positioning of the Door Floor Guide by centering the Door Floor Guide with the Wall Mount. Use a level or a plumb line to determine the exact center.



For **FULLY OPEN installation only**, you can measure from the edge of the doorway to the right 3-7/8". This will provide the center location for the Door Floor Guide.

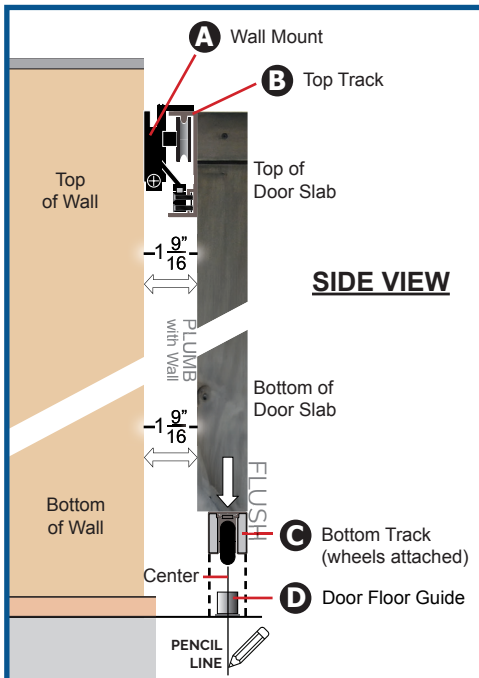

Next, you'll need to measure the distance from the wall to the Door Floor Guide.

2 Distance From Wall

OPTION 1: We recommend to attach the Door to the Wall Mount to locate the center for the Door Floor Guide. Once the door is securely attached, ensure that it is PLUMB with the wall. If the door opens & closes smoothly and remains level, identify the mid-point of the Bottom Track and mark it on the floor. See page 20, *Install the Door Slab*, for further information.

INSTALLATION STEPS:

STEP FOUR: Attach Door Floor Guide

2 Distance From Wall

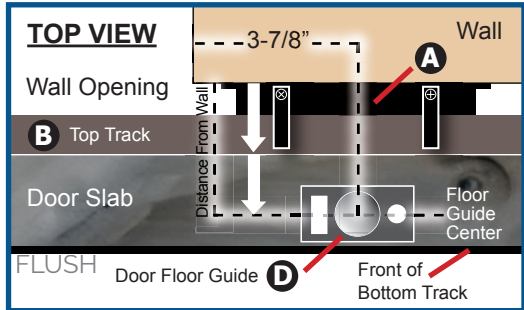
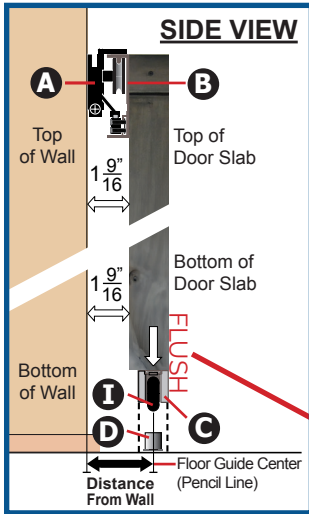

$$\left(1 \frac{9}{16} + \text{Door Thickness}\right) - \left(\frac{11}{16}\right) = \text{Distance From Wall}$$

OPTION 2: Use the formula above only if, (1) The door is plumb with the wall, and (2) The Bottom Track has been installed **FLUSH** with the Door Slab as shown in the image to the left. (For further information, see page 12, *Install the Bottom Track*.)

B. Attach -

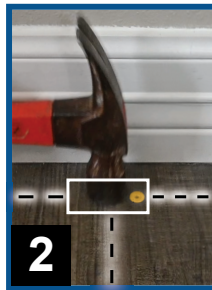
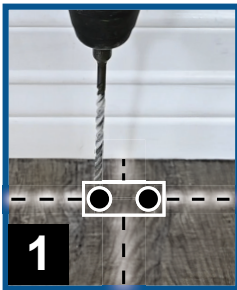

After using a pencil to mark the Door Floor Guide holes, use a drill to make two holes. Next, insert the (2) anchors in to the holes. Use the provided screws to firmly attach the Door Floor Guide. **Do Not Over-Tighten.**

DISCLAIMER: The Houdini Hardware™ Kit has screws and anchors included in the package. Know that the components provided may not be suitable for all other installations. Example: When installing the Wall Mount or Door Floor Guide, additional screws and anchors maybe required. And always ensure all components are properly secured. The weight capacity for the Houdini Hardware™ Kit should not be exceeded (80kg/176 lbs.) Follow all instructions accurately as stated in the installation guide.

INSTALLATION STEPS:

STEP FIVE: Install The Door Slab

A. Install -

Stand up the Door Slab with all the Top & Bottom Track components attached correctly in place. The center of the Door Slab should be relatively centered to the location of the Wall Mount. Two people should lift the Door Slab about 1" in height over the Door Floor Guide and over the Wall Mount guide wheels.

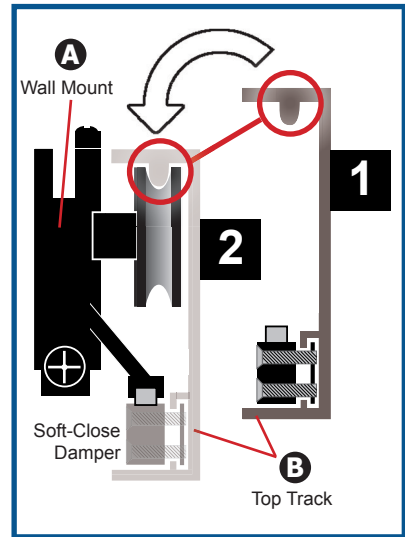
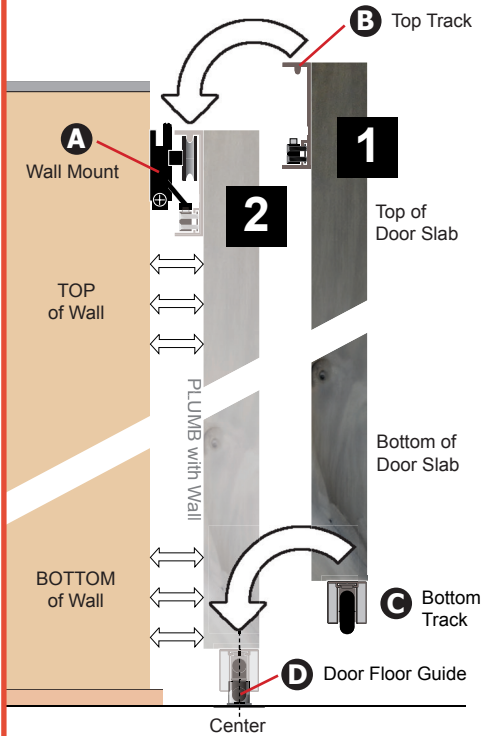

Slowly lower the door, making sure that the grooved wheel on the Wall Mount fits inside the Top Track Channel and, at the same time, the Bottom Track is lowered over the Door Floor Guide.

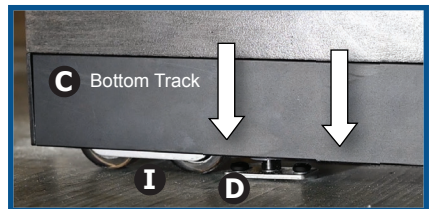
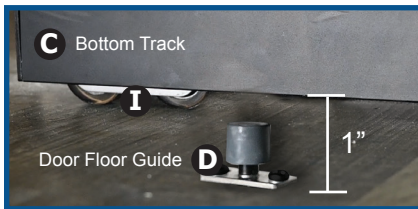

DISCLAIMER: Ensure the door slab is parallel with the wall. If the wall is not parallel with the slab, then the Wall Mount may need to be shimmed to allow for equal spacing between the back of the door and the surface of the wall in both open and closed positions.

INSTALLATION STEPS:

STEP FIVE: Install The Door Slab

B. Secure -

Once the slab has been installed and operates smoothly, locate the **(2) anti-jump bars at the top of the Wall Mount**. Rotate each 90 degrees to extend over the Top Track. Tighten each with a screwdriver. **This step is critical to ensure the safe operation of your rolling door.** The correct positioning of these anti-jump bars ensures that the door cannot jump off the top track and disengage from the Wall Mount and the wall.

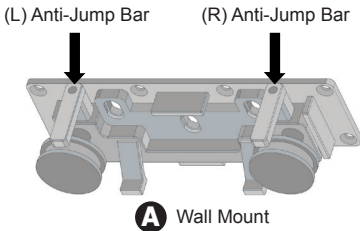

For Minimally Uneven Floor Surface - ADJUSTMENT SCREW

Slight adjustment may be required for the rollers of the Wall Mount. With a Philips screwdriver the **wheel assembly can be raised 1/4" in height** accommodating most floor conditions. The adjustable roller assembly has a fixed maximum distance between the rollers and the anti-jump bars. This is a safety feature and should not be altered in any manner. If the slab moves smoothly in the open and closed positions then no adjustment is needed. Turning the screw clockwise raises the roller assembly. Adjust the roller assembly as needed until the door moves smoothly in both the open and closed positions.

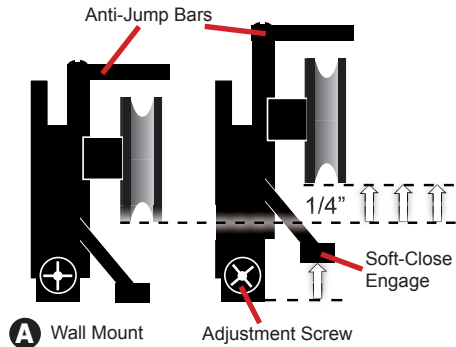

DISCLAIMER: The weight of the Door Slab is carried by the Wheel Assembly in the Bottom Track. The Wall Mount is only designed to be a guide and to keep the door slab in an upright position. Altering the anti-jump bars or improper use may result in damage, bodily harm or death.

SPECIAL INSTALLATION:

SPECIAL INSTALL: (Metal Brackets) For Metal Doors Only

A. Measure and Cut Top & Bottom Tracks to Size -

Measure width of the Door Slab and subtract the thickness of the (2) Top Track End Caps (3/16") to determine CUT SIZE of the TOP TRACK.

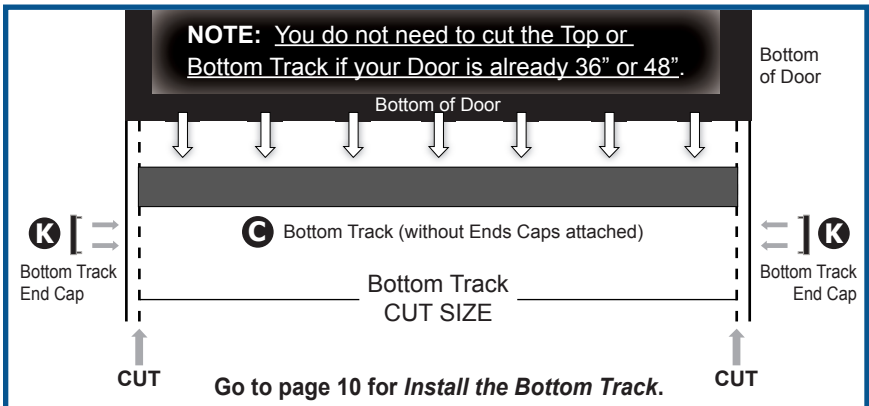
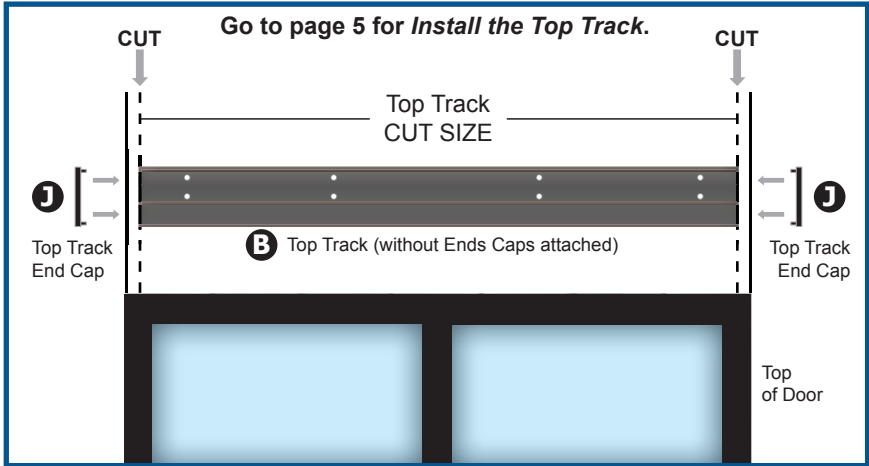

MAGIC TIP



A special adapter is required specifically for metal barn doors. This adapter is available as kit #BDHHA.

When installing the Bottom Track, use 1/2" self-tapping screws.

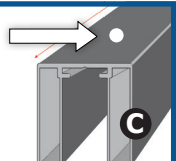

SPECIAL INSTALLATION:

B. Install Bottom Track -

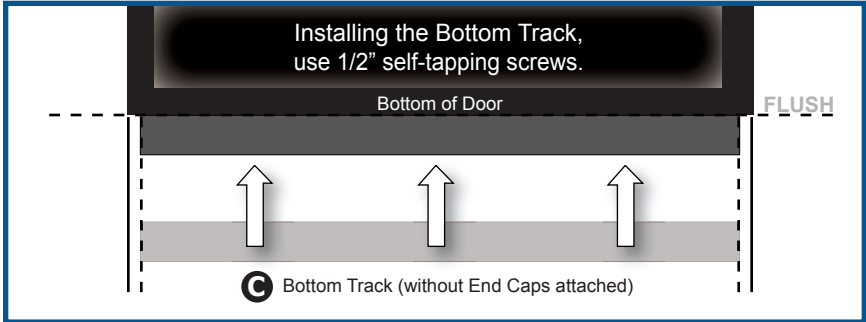

C. Install Mounting Brackets to Top Track -

Install the (2) Mounting Brackets to the Top Track, one at each end. Attach using **M4 Flat Head Screws**, (4) per Mounting Bracket

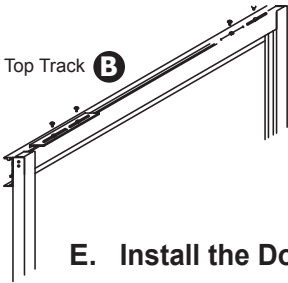
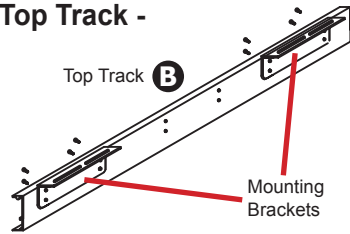

D. Attach Top Track to Top of the Door -

Attach the Top Track Assembly to the Top of the Door using **M6 Pan Head Screws**. Adjust the Top Track flush with the ends.

E. Install the Door -

After you have attached both the Top & Bottom Tracks, your door is ready to be installed. Installation is the same procedure as other barn doors utilizing the Houdini Hardware™ Kit.

BarnCraft 6 / Lite 1 Panel Contemporary Metal Door is used for this installation. All images shown are representations of the door.

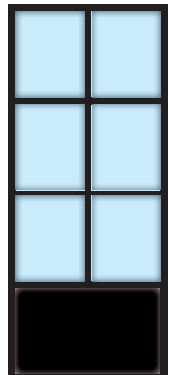

MAGIC TIP



For Further Information:

- (See pages 14-17, *Attach Wall Mount*)
- (See pages 18-19, *Attach Door Floor Guide*)
- (See page 20, *Install the Door Slab*)